

Corrosion Proof

Lifetime warranty against failure due to corrosion.

Permanent Magnet Motor

Maximum torque instantly with the power to cut through potential jams.

Removable Splash Guard

Removable splash guard, ideal for easy cleaning and replacement.

Attached Power Cord

Ready to plug in.



1/2 HORSEPOWER

3-BOLT MOUNT SYSTEM

For fast replacement of existing 3-Bolt installations.



BIO SHIELD® Antimicrobial for ODOR PROTECTION!

Disposers are treated with an antimicrobial agent molded inside providing protection against odor causing bacteria growth.



TORQUE MASTER® Balanced Grinding System.

A combination of computer designed and balanced components working in unison to provide superior torque grind speed and long system life.

HORSEPOWER	1/2 HP
MOTOR SPEED RPM	2600 RPM
VOLTAGE	120v
AMPS	4.5
CYCLES	60
BEARINGS	Permanently Lubricated, Sleeve Type
MOTOR TYPE	Permanent Magnet
SPLASH GUARD	Removable
GRIND RING	Stainless Steel
SWIVEL IMPELLERS	Stamped Stainless Steel
BALANCED TURNTABLE	Stainless Steel
BALANCED ARMATURE SHAFT	Yes
HOPPER	Corrosion Proof
DRAIN HOUSING	Corrosion Proof
APPLIANCE PROTECTOR	Manual Reset
SINK FLANGE	Stainless Steel
MOUNT ASSEMBLY	3-Bolt
SOUND SHELL	Partial
ATTACHED POWER CORD	Yes
DISHWASHER CONNECTION	Yes
UNIT WEIGHT	9.6 lb
INDIVIDUAL SHIPPING WEIGHT	11 lb
LIFETIME CORROSION GUARANTEE	Yes
WARRANTY	3 Years

Dimensions

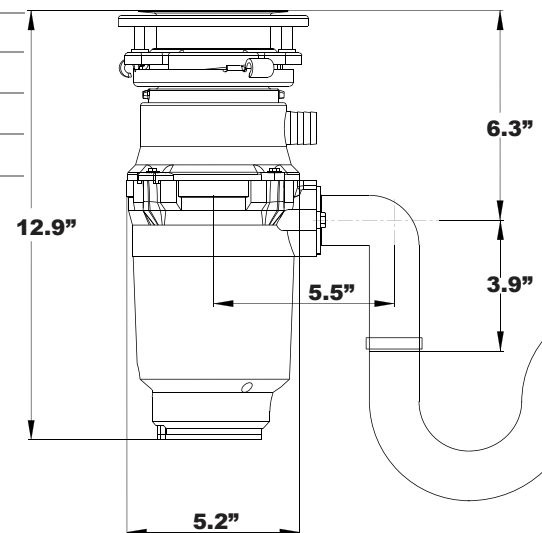

Joneca Corporation

4332 E. La Palma Avenue, Anaheim, California 92807
 Telephone: 714.993.5997 Fax: 714.993.2126 Toll Free 1-888-8Joneca
 Website: www.Joneca.com Email: ContactUs@Joneca.com

©2019 Joneca Corporation, All Rights Reserved.

SS-WM158-3B-191